



-  **Descripción/** Multijuego con 2 torres, una de ellas de 2,8m de altura con tejado. Juegos adicionales: Tobogán de acero inoxidable, puente curvado inclinado, escalera de acceso, peldaños de cuerda y paneles educativos en inglés.
- Materiales/**
- Pino Rojo del Norte, tratada en autoclave a nivel P4 y acabada con lásur, protector de la madera a poro abierto, hidrófugo, fungicida y con doble filtro anti U.V.
 - Polietileno de alta densidad, libre de mantenimiento y antigraffiti.
 - Rampas y puentes en polietileno revestido de caucho antideslizante.
 - Cuerdas de polipropileno con alma de acero.
 - Partes metálicas de acero inoxidable, acero galvanizado y acero con pintura de poliéster termoendurecida.

-  **Description/** Playset with 2 towers, one of them 2,8 m high with a roof. Additional games: Stainless Steel slide, curved tilted bridge, stairs, rope steps and English educational panels.

- Materials/**
- P4 Vacuum pressure treated Pine wood structure, with open pore, waterproof, fungicide and ultraviolet radiation lasur protection.
 - Anti-graffiti, maintenance free HDPE.
 - Rubber covered HDPE in ramps and bridges.
 - Steel- core polypropylene ropes.
 - Stainless, thermohardened painted Steel and galvanized Steel metal parts.

-  **Description/** Structure multijeu avec 2 tours, dont une de 2,8 m de hauteur avec toit. Jeux additionnels: toboggan en acier inoxydable, pont courbe incliné, escalier, échelons en corde et panneaux éducatifs en anglais.

- Matériaux/**
- Structure en Pin du Nord, traité en autoclave et finition lasurée, protecteur du bois à pores ouverts, hydrofuge, fungicide et avec double protection U.V.
 - Polyéthylène haute densité, libre d'entretien et antigraffiti.
 - Rampes et ponts revêtus de caoutchouc antidérapant.
 - Cordes en polypropylène avec âme en acier.
 - Pièces métalliques en acier inoxydable, acier galvanisé et acier avec peinture polyester thermodurcie.

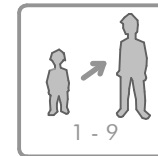
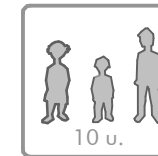
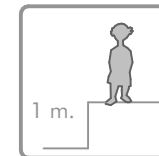
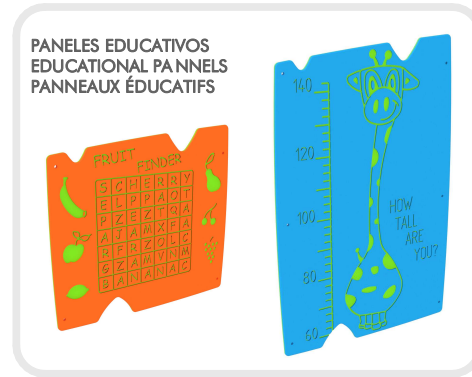

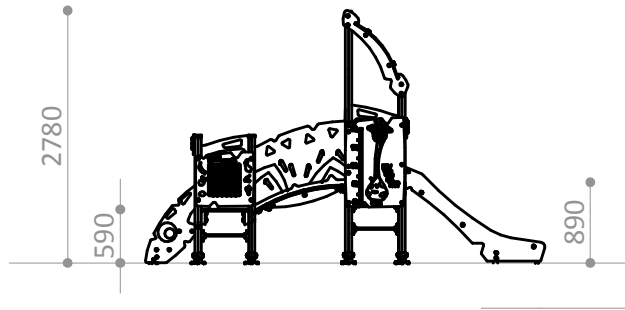

ESPACIO DE SEGURIDAD / ALTURA DE CAIDA LIBRE
SAFETY AREA / FREE HEIGHT OF FALL
ZONE DE SECURITÉ / HAUTEUR DE CHUTE LIBRE

A – 18,2 m² / 1 m
B – 4,5 m² / 0,59 m
A + B = 22,70 m²

Superficie según EN-1176-1
Surface according to EN-1176-1
Revêtement conformément à la Norme EN-1176-1

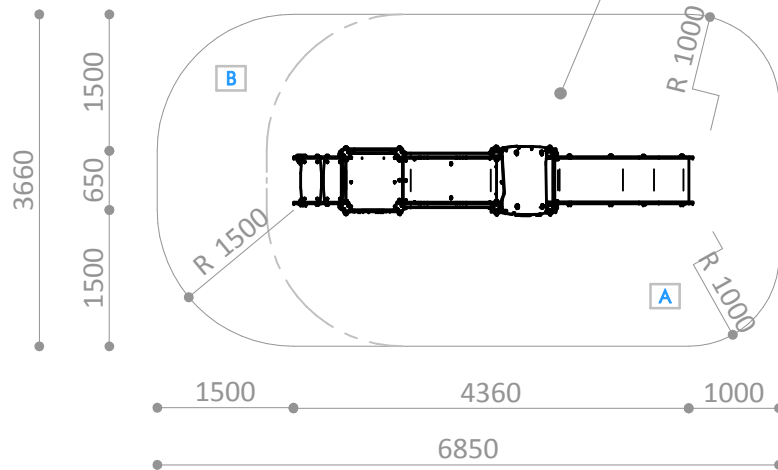

TORRE R4207-01

Pieza más grande
Biggest part
La plus grande pièce



TORRE R4207-01

Pieza más pesada
Heaviest part
La pièce la plus lourde



64 Kg.

R4207XA

Suelo de hormigón
Concrete ground
Fixation sur béton

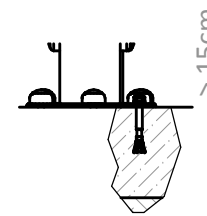

x36

R4207XE

Otros suelos
Other grounds
Autres sols

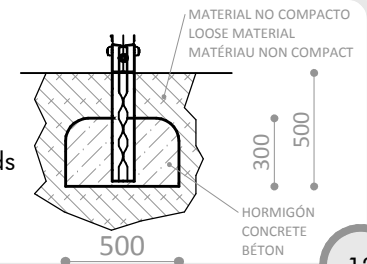

x12

Disponibilidad de repuestos durante 10 años.
Spare parts available for 10 years.
Disponibilité de pièces de rechange pendant 10 ans.

Industrias Agapito se reserva el derecho a modificar sin previo aviso los elementos descritos en este documento.
Industrias Agapito reserves the right to change the items described in this document without prior notice.
Industrias Agapito se réserve le droit de modifier à tout moment et sans préavis les éléments décrits dans le présent document.



R4207X

VELETA EN LINEA
LINED-UP VELETA
VELETA EN LIGNE DROITE

FICHA TECNICA
TECHNICAL SHEET
FICHE TECHNIQUE
FT-R4207Xrev05 - 3/3

